

100-240V

1>õ)Ñ9frë



Rain300

IDV

PC

Rain300

Intel

4K

1

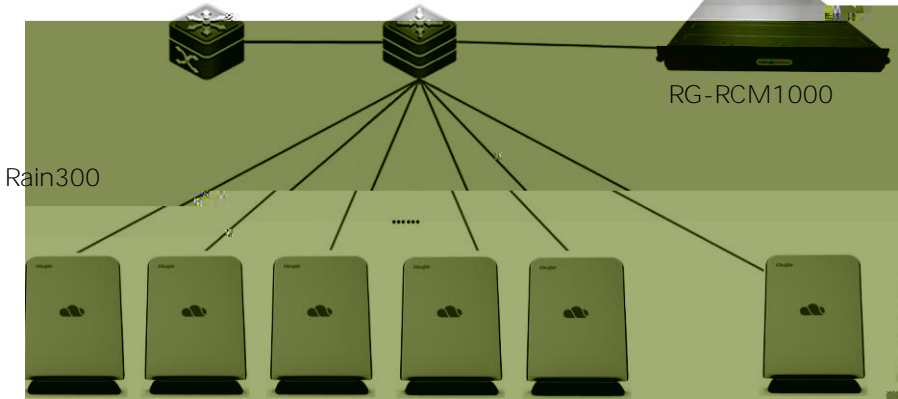

1 Rain300

1 Rain300

1		1	
2		1	
3		1	
4		1	
5		1	
6		1	

2 Rain300

	Rain300
CPU	Intel
	4GB
	128GB SSD
	1920× 1080@60Hz

VESA		VESA	100×100mm		
		Kensington			
		12V-4A			
I/O		DC	5.5mm×2.5mm		
		VGA	HDMI		
		4	USB 2.0	2	USB3.0
		10/100M/1000M			
		3.5mm			

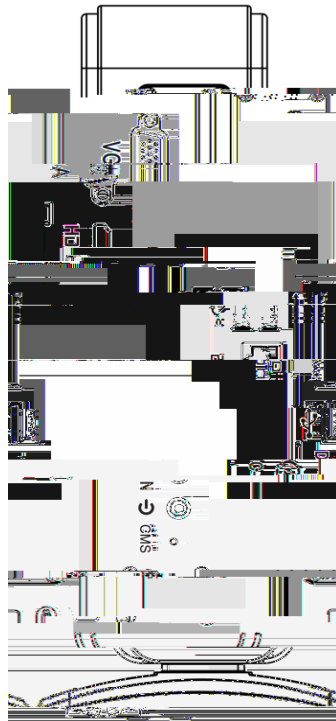
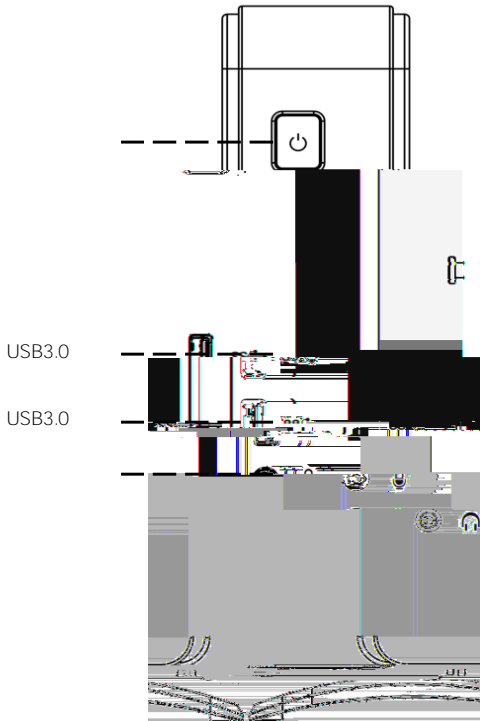

2 Rain300

Rain300

10cm

Rain300

0°C 40°C

-10°C 50°C

10% 90%

5% 95%

48

15

Rain300

3

Rain300

1. Rain300

2.

3. Rain300

power

6

- 1.
- 2.

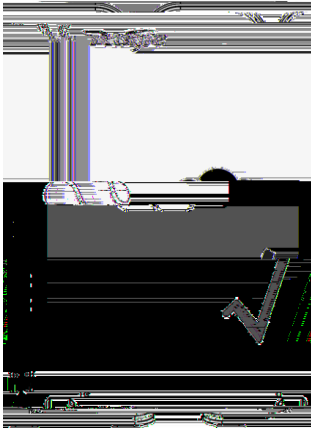
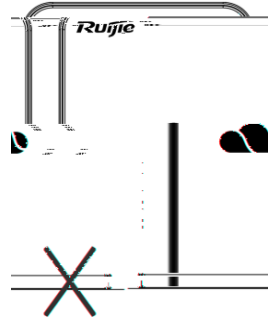
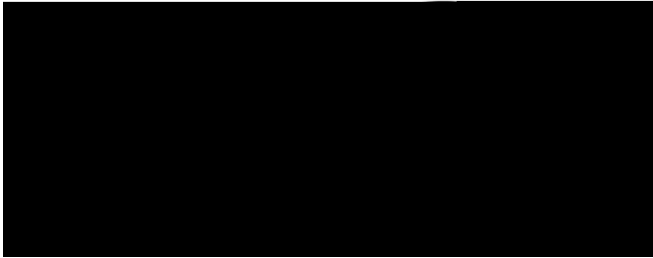

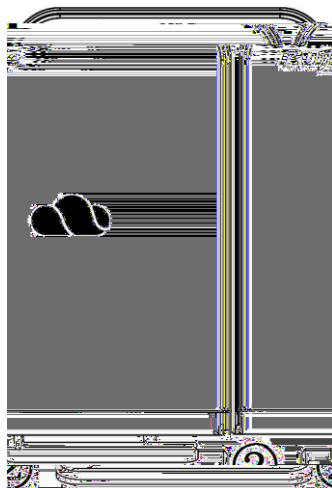

1.

2.

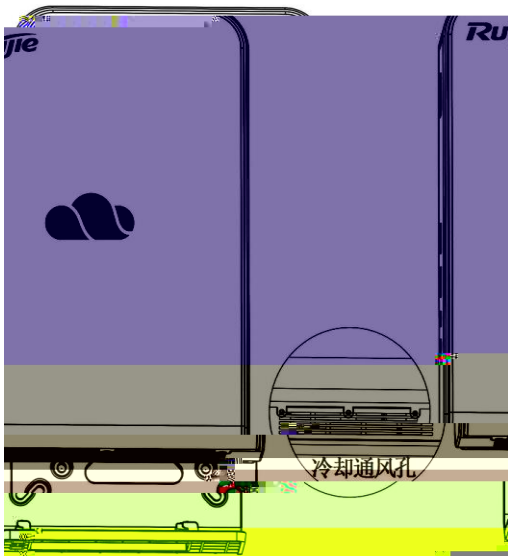
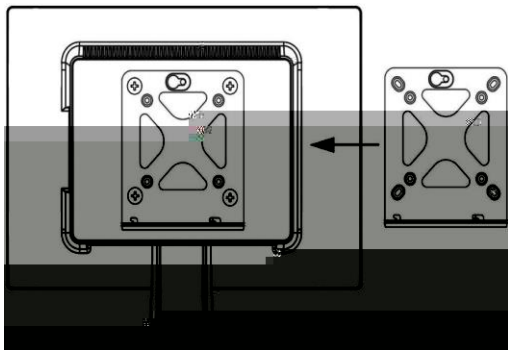

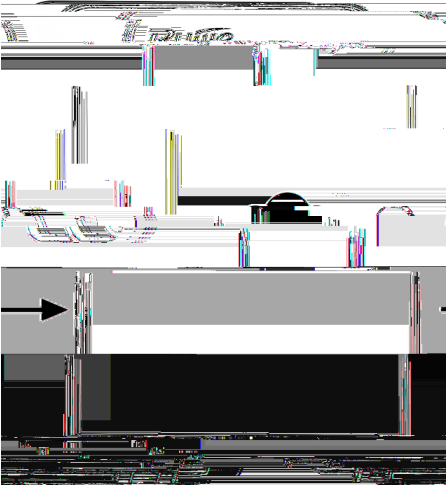
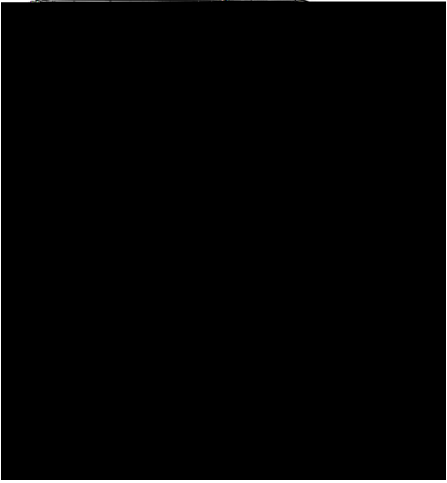

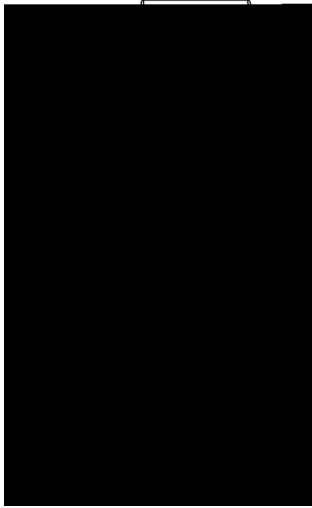

SJ/T11364-2006"

"

	Pb	Hg	Cd	Cr VI	PBB	PBDE
PCB	x					
	x					
x	SJ/T11363-2006					
	SJ/T11363-2006					
1						
2						
3						

4008-111-000

<http://www.ruijie.com.cn>

Statement

Ruijie Networks ©2000-2017

Ruijie Networks Co., Ltd. All Rights Reserved.

Thanks for using Ruijie products.

Ruijie strongly recommends that you carefully read this manual before using the device. If you perform operations on the device without reading this manual, Ruijie assumes no responsibilities for any losses incurred. In addition, Ruijie may make small adjustments to the device to enhance the device performance, which may result in slight difference between operations described in this manual and actual operations. We are sorry for that but you can rest assured that the adjustments will not affect your use.

Product Overview

Ruijie Cloud Desktop terminal of the Rain300 series is a computer office solution developed for industries such as education, government, medical and enterprises. By adopting the new intelligent desktop virtualization (IDV) architecture, the product is used to address management of traditional PC office, is capable of processing rich media, and is highly reliable independent of the network, thus effectively improving user experience.

The intelligent Cloud Desktop terminal of the Rain300 series is the core component of Cloud Office Lightning and Cloud Class Enhanced. This terminal is designed without fans (compatible with fans). The product is configured with Intel high-performance processor and an integrated graphics card, supports 4K high-definition video display, and can be used for complex applications such as education, government, medical and enterprises, and for rich media. The intelligent Cloud Desktop terminal is associated with the cloud management server to implement efficient centralized management of multiple terminals

Product Specifications

Table 2 RG-Rain300 Specifications

Model	RG-Rain300	
Feature	Indoor Cloud Desktop terminal, embedded with thin client	
CPU	Intel high performance processor	
Memory	4 GB onboard memory	
Storage	128 GB SSD	
Resolution	1920 x 1080@60Hz	
VESA Mounting	Support; Hole Pattern: 100 x 100 mm	
Security	Support security lock (For example, Kensington)	
Features	Auto power-on (optional) and Wake-on-LAN	
Supported Power	12 V, 4 A power adapter	
I/O	Power Interface	DC interface (5.5 mm x 2.5 mm)
		VGA/HDMI interface
	Data Interface	

Operating Temperature	0°C to 40°C (32°F to 104°F)
Storage Temperature	-20°C to 60°C (-4°F to 140°F)
Operating Humidity	10% to 90% (non-condensing)
Operating Altitude	
Power Consumption	25 W
Dimensions (L x W x H)	163 mm x 100 mm x 239 mm (6.42 in. x 3.94 in. x 9.41 in.)
Weight	2.05 kg (4.52 lbs)

Interfaces

Interface Positions

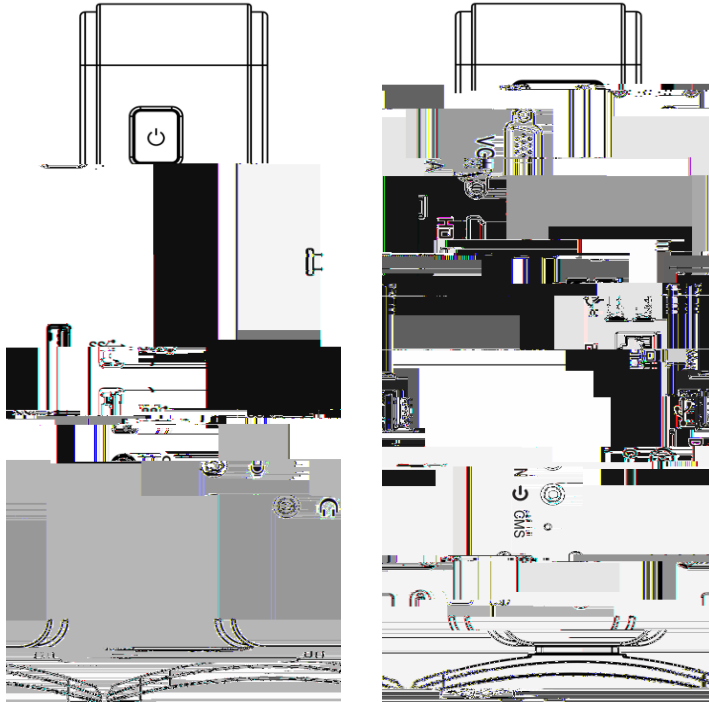

Figure 2 Interface Positions of the Rain300

Interface Description

Power button: The device is switched on if you press this button for a short period of time and is switched off if you press this button for a long period of time. The LED of the power button is on when the device is switched on.

USB3.0 single interface: Indicates one USB3.0 interface. It is used to connect to a USB3.0 device such as a USB flash drive and is compatible with USB2.0 devices.

Microphone input interface: Connects to microphone to implement the input of audio signals.

Headset output interface: Connects to headset to implement the output of audio signals.

USB2.0 dual interfaces: The Rain300 has two USB2.0 dual interfaces, each USB2.0 dual interfaces has two USB2.0 interfaces arranged in two lines, and each USB2.0 interface can be used to connect to a USB2.0 device such as the keyboard or mouse.

HDMI interface: Connects to a display device that supports the high-definition multimedia interface (HDMI) interface.

VGA interface: Connects to a display device that supports Video Graphics Array (VGA) interface.

Network interface: Connects to network cable to implement the Internet access function.

Power interface: Connects to the supplied power adapter and supports 12 V/4 A power adapter input.

Security lock hole: Uses a security lock (for example, Kensington security lock) to implement the anti-theft function.

Reserved power button: Powers on/Powers off the device via a 3.5 mm audio cable.

CMS: Indicates a Clear CMOS button which is used to restore CMOS settings to factory defaults.

Preparation before Installation

Installation Environment

The RG-Rain300 must be used indoors. The installation environment needs to meet the following requirements to ensure proper running of the ded%CD[u]96(s):19(n)199(e)96()JEMC /P

Dust is hazardous to device running. Dust accumulated on the device can cause electrostatic adsorption, resulting in poor contact of metal connection points. Especially, when the indoor relative humidity is low, electrostatic adsorption is more serious, which may affect the device service life and easily cause communication failures. The RG-Rain300 has requirements for dust in the computer room. Therefore, do not use the device in a dusty or dirty environment to prevent system failures.

Installation Tools

Table 4 Tool List

Common Tools	Phillips screwdriver, cables, screws, straps
Special Tools	Anti-static tools, multimeter

Users need to get the preceding tools ready except the standard configurations delivered together with the RG-Rain300.

Notes

1. Disconnect the power supply before installing or moving the RG-Rain300.
2. Ensure that screws are installed tightly and securely.
3. Install the RG-Rain300 in a proper place easy for observing the power LED.

Installation Steps

Installation Precautions

1. Before installation, check the installation mode of the host and use the base or mounting bracket for installation.
2. The device is designed without fans; therefore, you must ensure that the device is placed upright and the cooling holes are smooth no matter whether the base or mounting bracket is used, ensuring proper functioning and achieving the best performance.

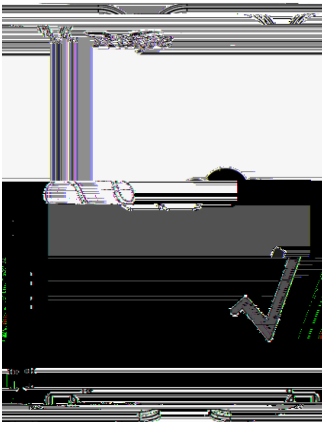
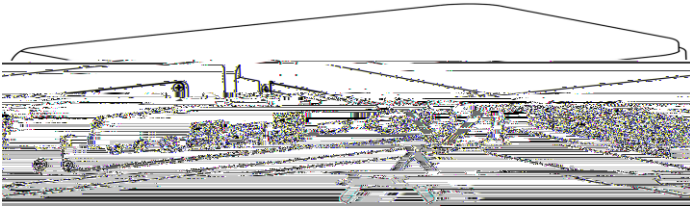
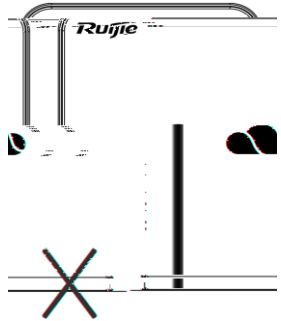

Installing the Base

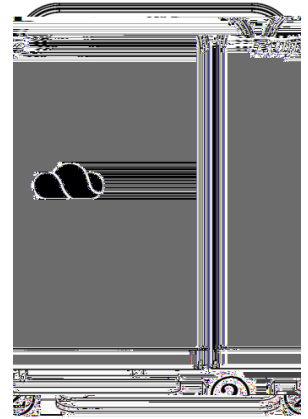
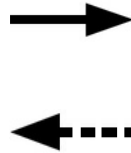
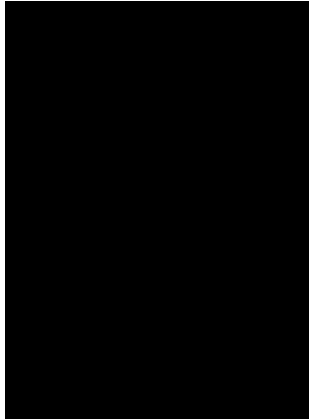

Installing and removing the base:

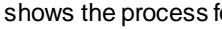
1. As shown in the figure,  shows the process for installing the base.
 - 1) Align the base fasteners with the ventilation holes on the bottom of the device.
 - 2) Insert the fasteners into the ventilation holes.
 - 3) Push the base into the middle of the device until the entire fasteners are clicked.
2.  shows the process for removing the base.
 - 1) Push the base to the edge of the device (in the opposite direction as in installation).
 - 2) Pull the base out.



Installing the Mounting Bracket

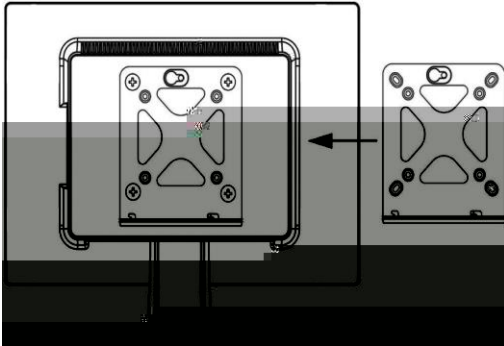

Step 1:

Attach the mounting bracket to the back side of the display using screws.

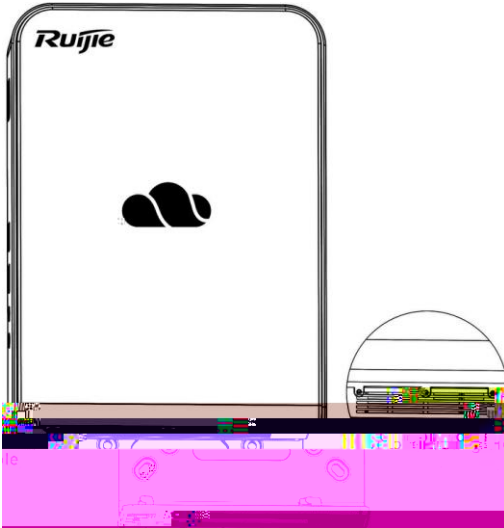

Step 2:

Align the cooling holes at the bottom of the device with the buttons of the mounting bracket.

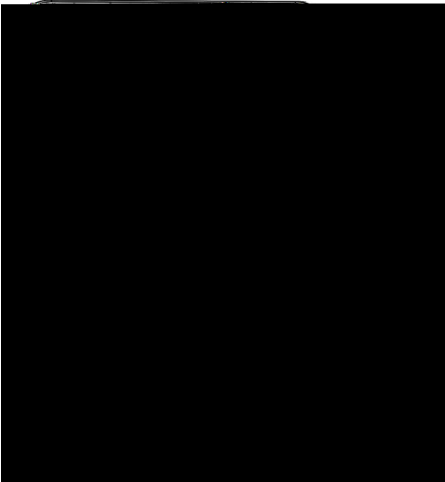

Step 3:

Move the device downward horizontally until the bottom is aligned with the surface of the mounting bracket.



Step 4:

Move the host rightward horizontally until the device is fastened on the mounting bracket.

Powering on and Starting the Device

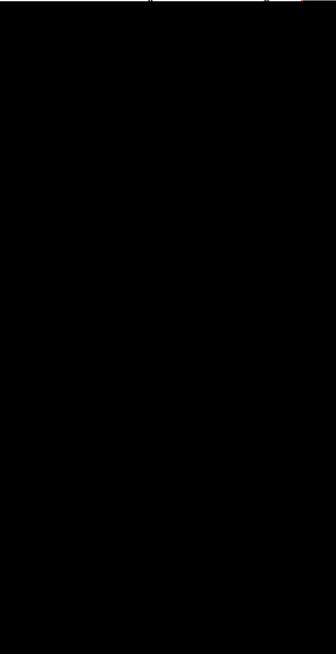

Press the power button on the RG-Rain300 to start the device. After the device startup is complete, the thin client automatically runs. The system automatically detects the thin client version upon startup each time. If a later version is detected, the system automatically downloads and installs the new version.

Ruijie Networks Co., Ltd.

Technical Support Hotline: +(86)4008-111-000
Website: <http://www.ruijienetworks.com>